

FERRAMENTAS NECESSÁRIAS
HERRAMIENTAS NECESARIAS
TOOLS NECESSARY

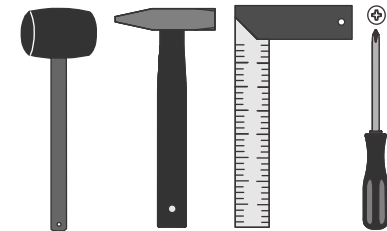

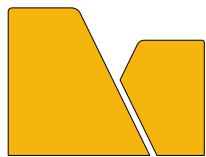











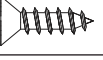

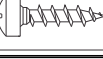

30 min



MULTIMÓVEIS
baby

Rua Carlos Dreher Neto, 1918, Fone: (54) 2102 4000, FAX: (54) 2102 4050
CEP 95700-000 - BENTO GONÇALVES - RS - BRASIL
CNPJ: 00.349.443/0001-92
e-mail: multimoveis@multimoveis.com / site: www.multimoveis.com

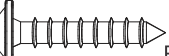
B			Parafuso 4,5 x 50	04
D			4,0 x 35	02
E			Parafuso 3,5 X 14	08
F			Parafuso 3,5 X 14	04
H			Cavilha 8,0 x 30	08
N			Paraf. Minifix	08
O			Tambor de Minifix	08
P			Tampa Plástica Tambor de Minifix	04
X			Sapata	04
AA			Dobradiça	02
BX			Bisnaga de Cola 5g	01
CJ			Articulador	01
DZ			Parafuso 4,0 x 30	04

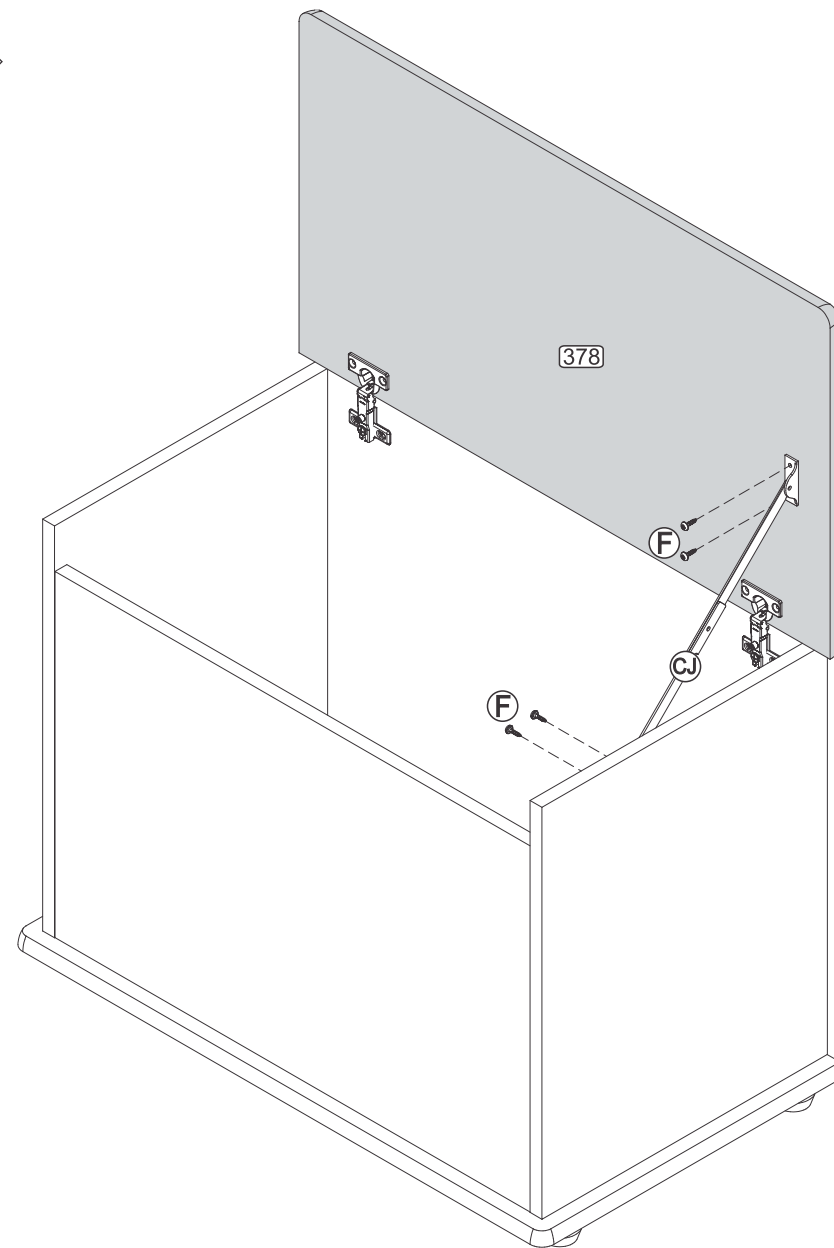

Utilizar a régua abaixo para medir as ferragens:

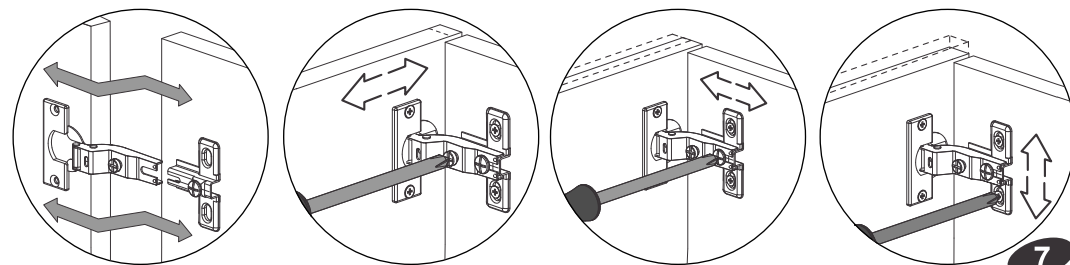
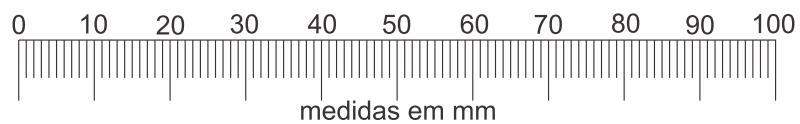

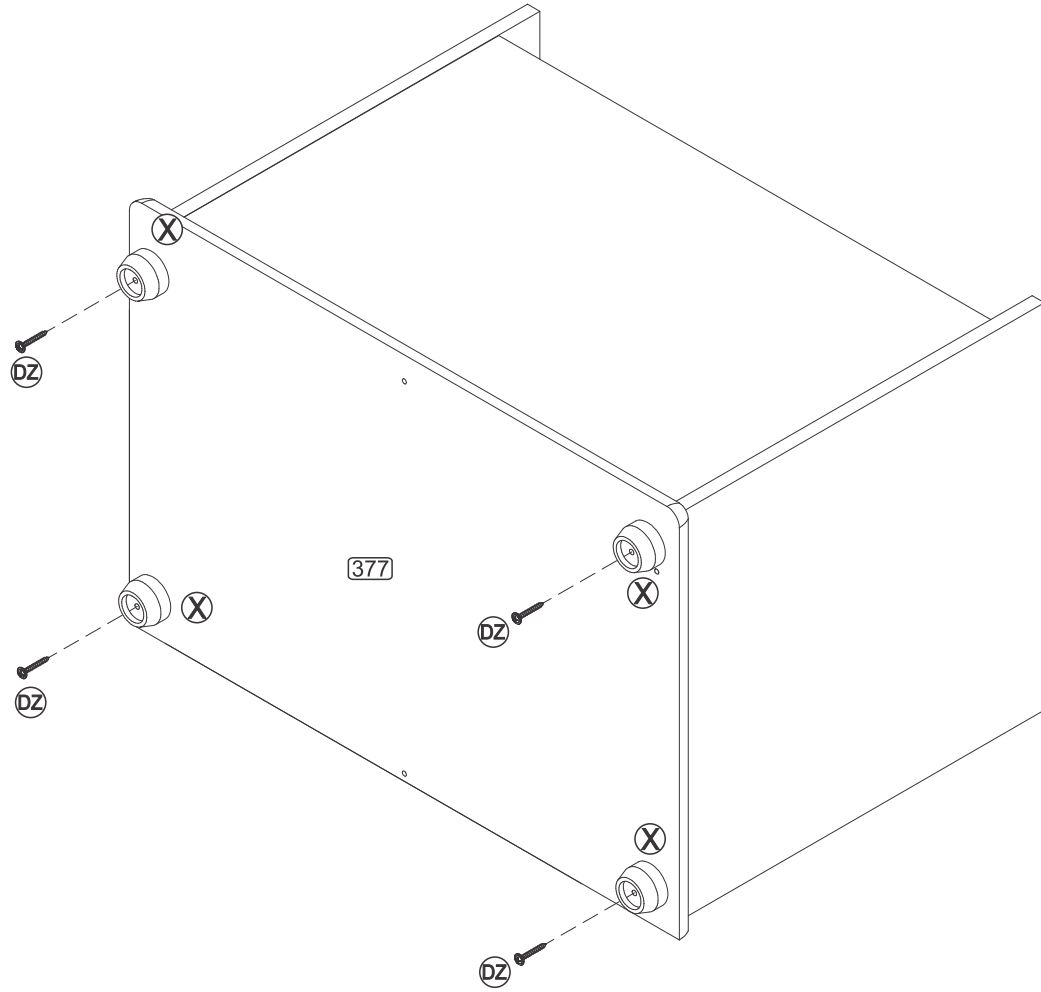

 Senhor montador!
Informamos que a numeração das peças encontra-se no topo das mesmas conforme desenho.

Señor Armador!
Les informamos que la numeración de las piezas se encuentran arriba de las mismas, de acuerdo al modelo.

Dear Assembler!
We inform you that the number of each piece is located on the top of it, according to the model.

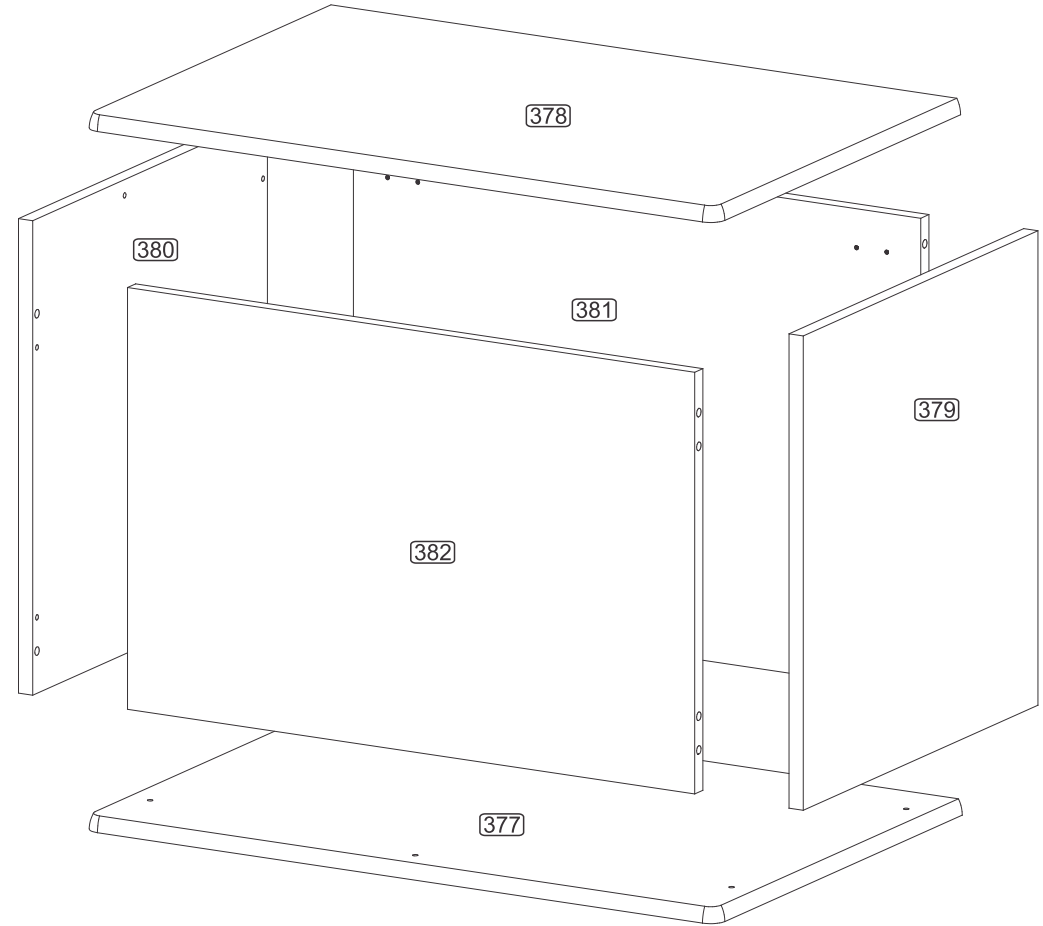

POR LISTA DE PEÇAS

Nº	DENOMINAÇÃO
377	BASE
378	PORTA BASCULANTE
379	LATERAL DIREITA
380	LATERAL ESQUERDA
381	COSTA MAIOR
382	COSTA

ESP LISTA DE PIEZAS

Nº	DENOMINACIÓN
377	BASE
378	PUERTA BASCULANTE
379	LATERAL DERECHA
380	LATERAL IZQUIERDA
381	RESPALDO MAYOR
382	RESPALDO

ENG PART LIST

Nº	DESCRIPTION
377	BASE
378	SWINGARM DOOR
379	RIGHT SIDE
380	LEFT SIDE
381	LARGER BACK
382	BACK

PRÉ-MONTAGEM / PRÉ-ARMADO / PRÉ-ASSEMBLAGE

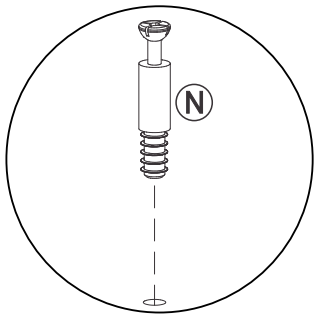
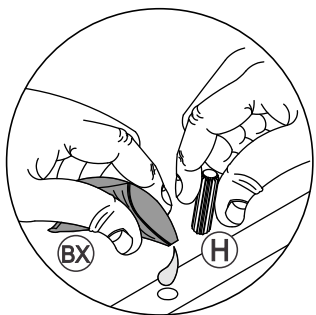
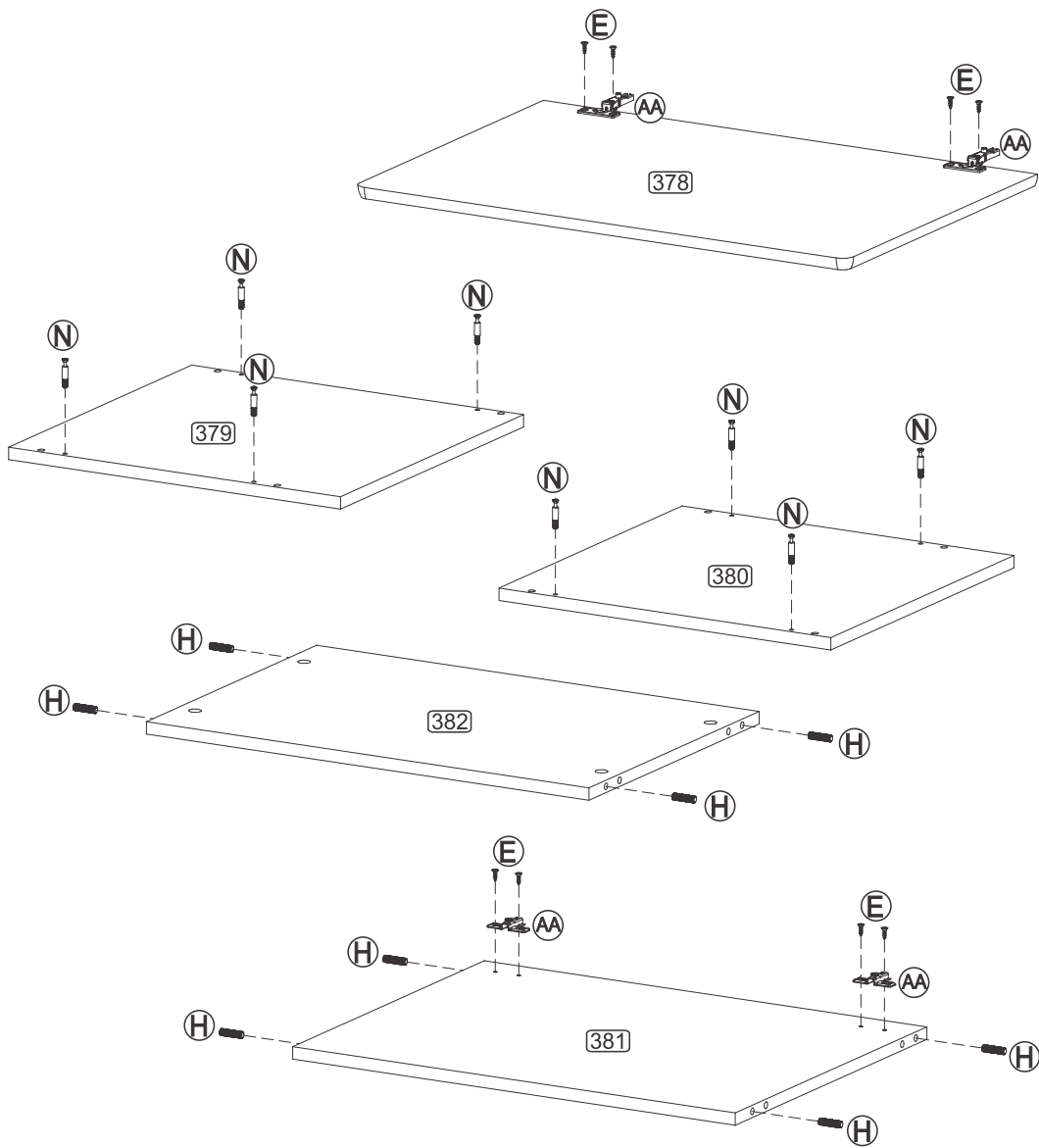

Passo
Paso
Step
01

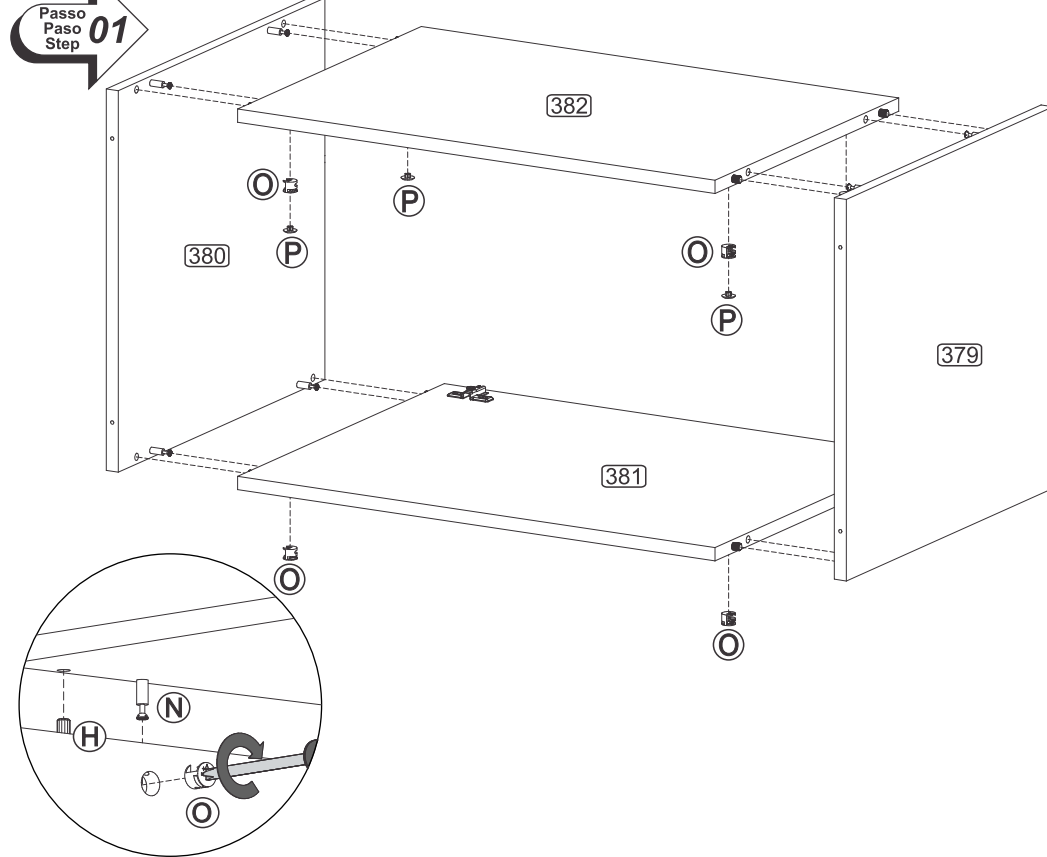

Passo
Paso
Step
02

